

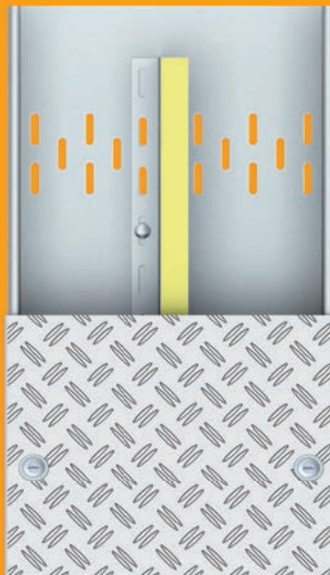

Walkable cable tray systems BKRS



CHALFANT

OBO Bettermann Group

We are Chalfant.
We are OBO.
We are One.

chalfant-obo.com

Chalfant Manufacturing Company

Chalfant Manufacturing has more than seventy years of experience designing and producing quality cable tray and cable management systems right here in the USA. Our sales team works closely with all customers to provide quality solutions that meet the tightest deadlines. Chalfant is involved in numerous organizations that further the improvement of cable tray production and installation. We are a founding member of the cable tray institute and active member of NEMA and BICSI.



Our commitment to innovating cable tray and wire management systems is a tribute to our long-standing reputation as one of the industry leaders in quality and customer service.

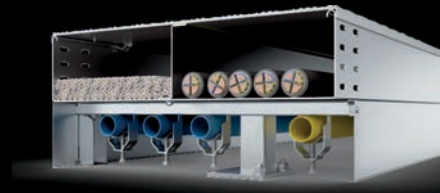

OBO Bettermann Group

CHALFANT

OBO Bettermann Group

Contents



**Walkable cable tray
systems, side height 4"**

Page 22

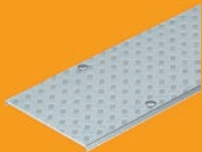

**System accessories
BKRS**

Page 24



Mounting systems

Page 26

Surfaces for indoor use



Whether indoors or outdoors, in aggressive atmospheres or under special hygienic conditions: Chalfant can offer the perfect surface and materials for your cable support system, no matter what the requirements may be. Chalfant cable support systems are machined from high-quality steel or steel wire and are available with various surfaces. Different hardening and coating methods ensure tailor-made corrosion protection, specially tailored to the appropriate application. In addition, Chalfant cable support systems are available in stainless steel in a variety of powder coated colors.

Indoor use

For applications in indoor areas, Chalfant can offer cable support systems with galvanization or strip galvanization. They are particularly suited to dry atmospheres without any impact from aggressive pollutants.

Strip galvanization / FS

- ASTM A653 and EN 10346 compliant Hot-Dip galvanized per strip galvanizing method
- Average coating thickness approx. 20 microns
- Metal punching protected by cathodic corrosion up to 2.0mm thickness



Surfaces for outdoor use



Outdoor use

Chalfant can offer versions with hot-dip galvanization and double-dip galvanization for outdoor and wet-room use.

Hot-dip galvanization / FT

- ASTM A123 and EN ISO 1461 compliant
- Coating thickness approx. 40–60 microns
- Any cuts made on site must be cold galvanized to prevent corrosion

Double-dip galvanization / DD

- Zinc-Aluminum coating ASTM A875 and EN 10346 compliant
- Average coating thickness approx. 23 microns
- Metal punching protected by cathodic corrosion up to 2.0mm thickness

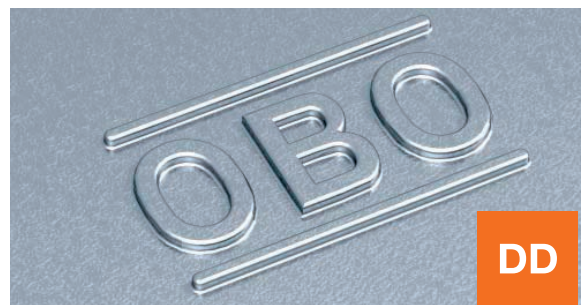



Reliable power and data supply for industry

Automated production lines and process systems construction applications consume very large quantities of energy and data, and in-turn require numerous cables. Chalfant walkable cable tray systems provide the ideal protection for these cables. The systems are tested according to UL, EN 61537 and on the basis of EN 50055-2-2, and guarantee extremely high load capacities and safety in industrial environments.

CHALFANT

OBO Bettermann Group





System sizes

BKRS cable tray is available in 4 1/3" (110mm) side heights. The dimensions and materials available mean that they satisfy the guidelines and requirements of numerous industries. With six widths between 4" (100mm) and 24" (600mm) available, there is a suitable cable tray system for every possible application.



Rugged connection

Heavy loads, stamping feet, dirt, dust – Chalfant enclosed, walkable cable tray systems can handle all this and more, thanks to their ingenious system design. With their excellent mechanical stability they offer effective protection for cables and provide optimal shielding to ensure electromagnetic compatibility.



Non-slip covers

The covers of the cable trays, with their aluminum checker plate surfaces, are non-slip to make sure workers are always on a solid footing. This also reduces the risk of accidents in everyday use.



Absolutely reliable

Chalfant walkable cable tray systems offer users safe access to machines and systems. All the system components can accept large loads on account of their construction. If all the mounting specifications are provided, we can guarantee a traffic load of up to 2023 lbs, depending on the installation type.



Material stability

The Z-shaped barrier strips are made from 12 gauge steel. For tray widths of up to 16", one barrier strip is sufficient, while for widths up to 24", two barrier strips should be used.



Additional mounting space

The support bracket allows the mounting of u clamps to guide additional media under the trays.

High traffic load

Cable tray is made from 12 gauge steel. The covers have an overall material thickness of 1/4".



12
gauge



Accident prevention

An optional protection plate prevents dirt deposits beneath the trays and also helps to prevent accidents.

Perfect protection

All kinds of conditions are encountered in modern industrial plants. Often the environment is harsh, with dirt, vibrations and other side effects of industrial processes posing a serious risk to sensitive power, data and control cables. Chalfant's "BKRS" walkable tray provides a safe, enclosed installation space for cables and lines.

EMC-tested

Through the use of a barrier strip, power, control and data cables are isolated to ensure electromagnetic compatibility. The trays and covers themselves provide perfect all-round protection for the cables.



UL Classified bonding

BKRS Cable Trays are UL classified as to their suitability as an equipment ground conductor.





Anti-slip strip

Self-adhesive, anti-slip strip for holding the cover in place during installation.



Dust protection

The dust protection elements on cover joints prevent the ingress of foreign bodies.



Assembly options to meet every requirement

The BKRS can be mounted – on stand-off brackets, on Z-shaped support profiles, or even directly on the floor.



Installation on stand-off bracket

- Maintains standard step height
- Meets health and safety guidelines regarding e.g. risk of slipping/tripping





Mounting on Z-shaped support profile

- Maintains standard step height

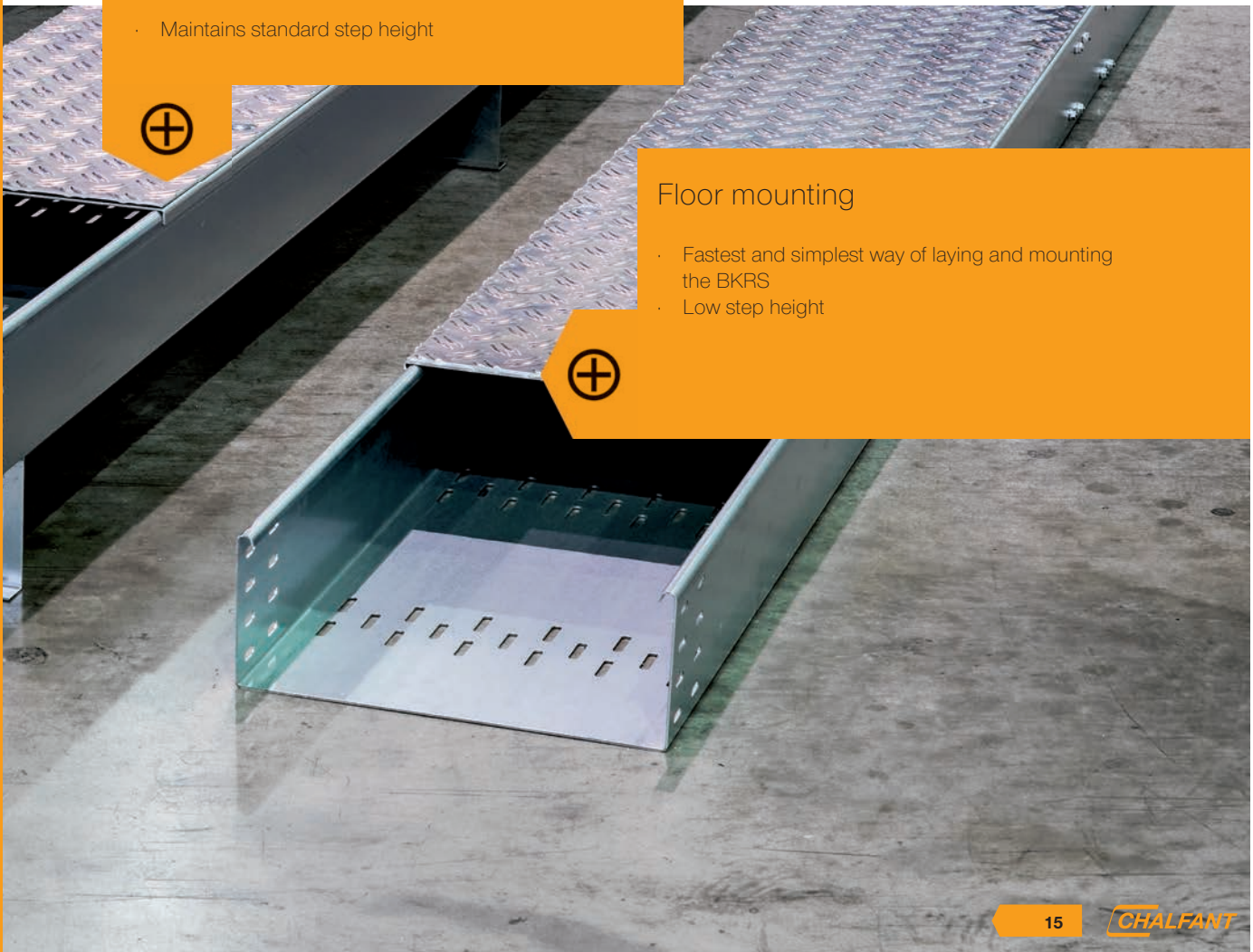

Floor mounting

- Fastest and simplest way of laying and mounting the BKRS
- Low step height



BKRS walkable cable tray system at a glance

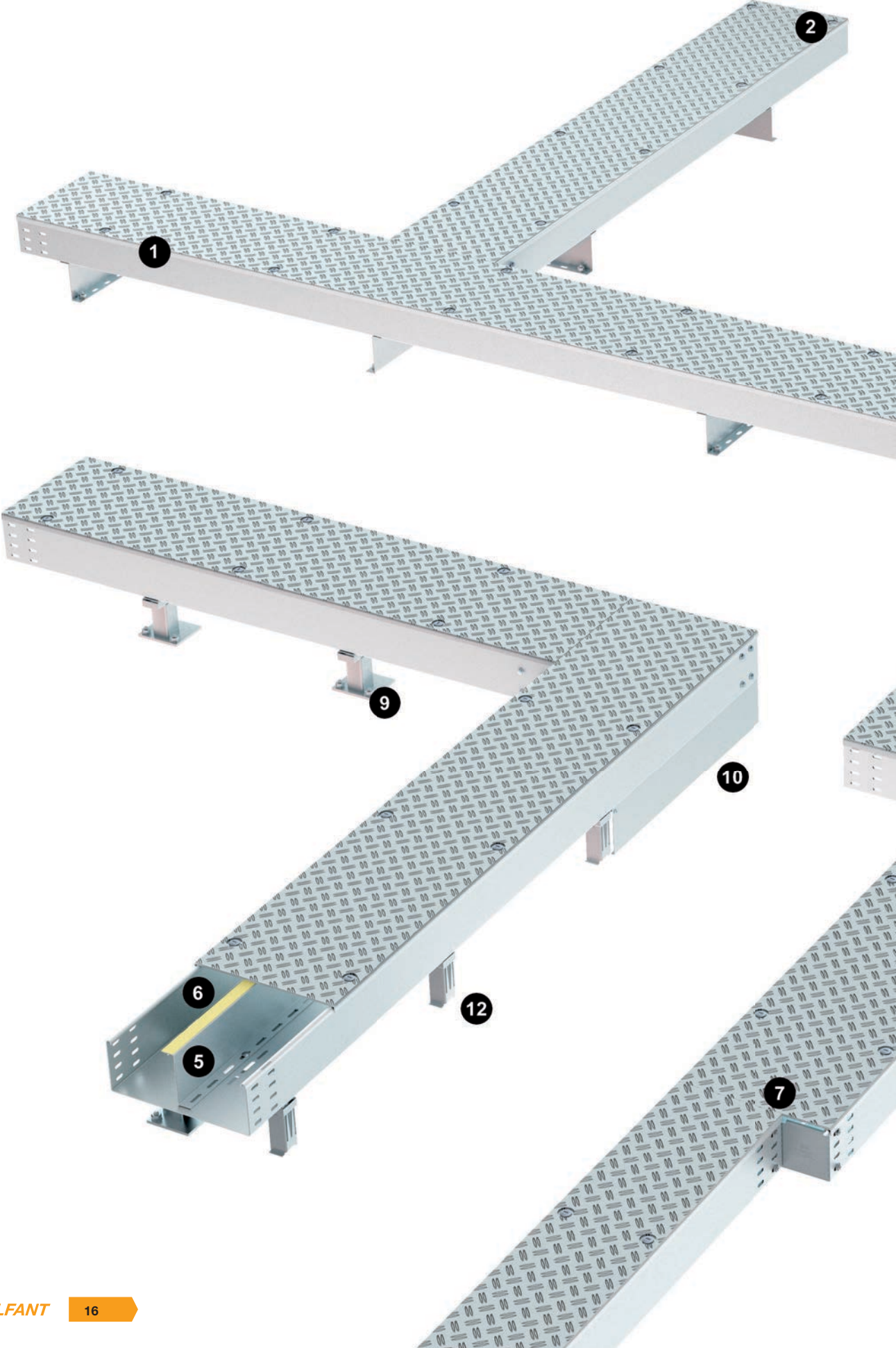

1	Cable tray BKRS
2	Cover with checker plate and turn buckle
3	Dust protection element
4	Cover support
5	Z-shaped barrier strip
6	Anti-slip strip
7	Reducing bracket
8	Support profile
9	Stand-off bracket
10	Protective panel
11	Equipotential bonding bar
12	Supplement bracket

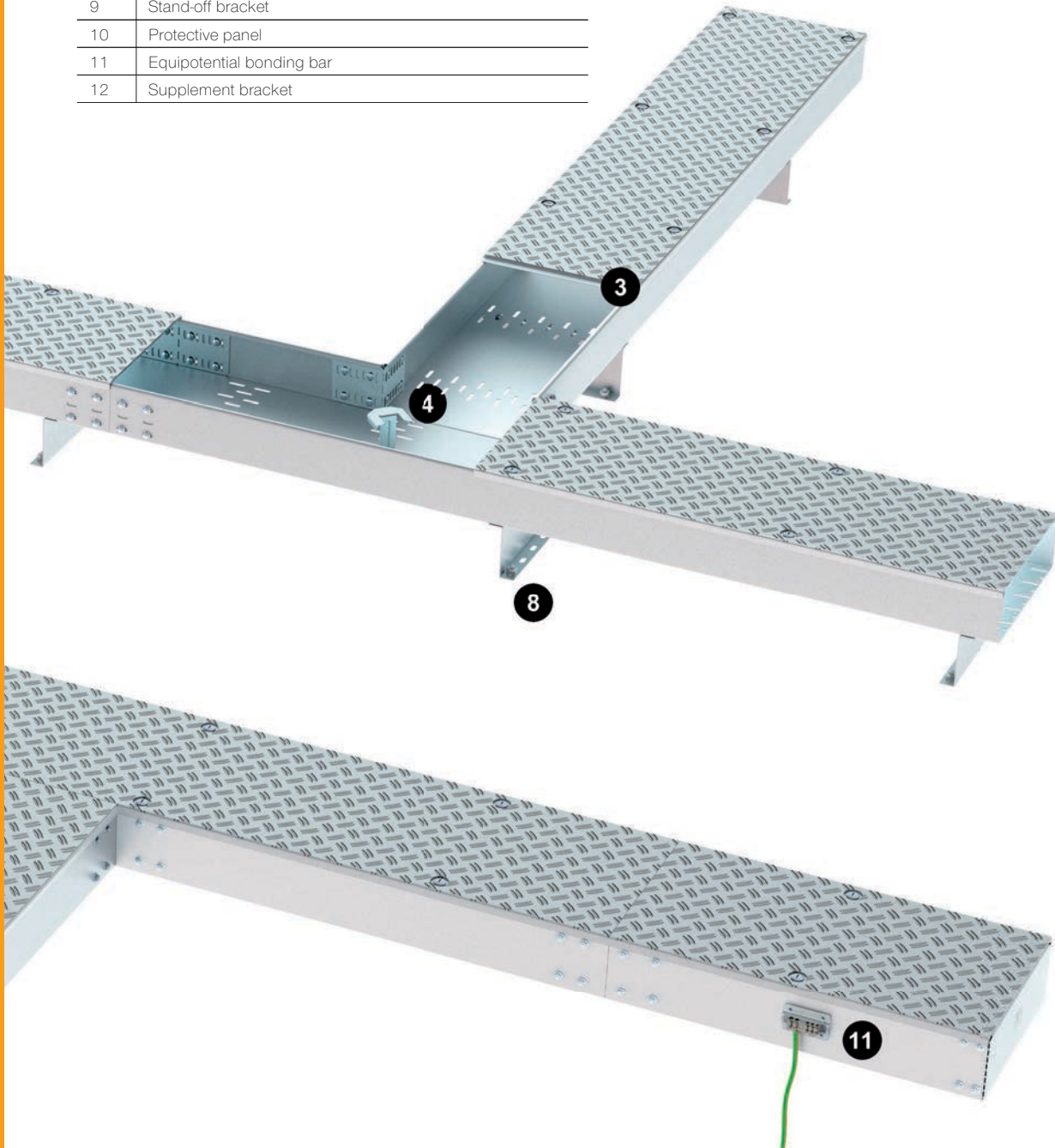

At our internal BET Test Center facility, we simulate the loads that the walkable cable tray systems have to withstand on a constant basis. We determine the maximum load capacity and carrying capacity of the system, as well as its resistance to dust and corrosion. This means that, as a systems provider, OBO Bettermann places paramount importance on safety.

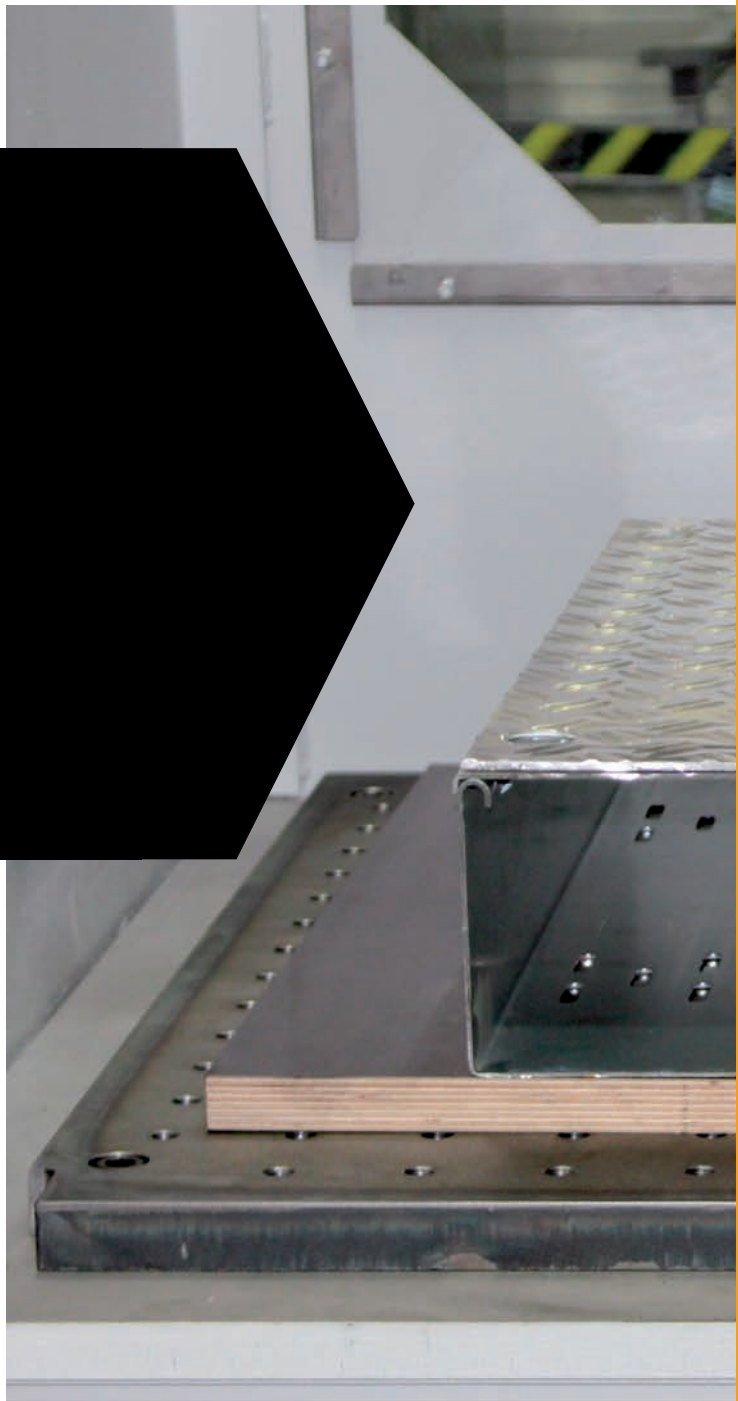

Standards

The BKRS walkable cable tray system from Chalfant conforms to the following standards

- UL classified - Cable management
- Based on DIN EN 50085 - Cable ducting systems for electrical installations
- DIN EN 50174 - Information technology - Cabling installation (EMC)

Through continuous controls and adherence to these standards, we ensure consistent quality and a high level of safety. Chalfant and OBO Bettermann play an active part in the development of new standards and guidelines and our employees participate in national and inter-national DKE, VDE, CENELEC, IEC and NEMA standardisation committees.

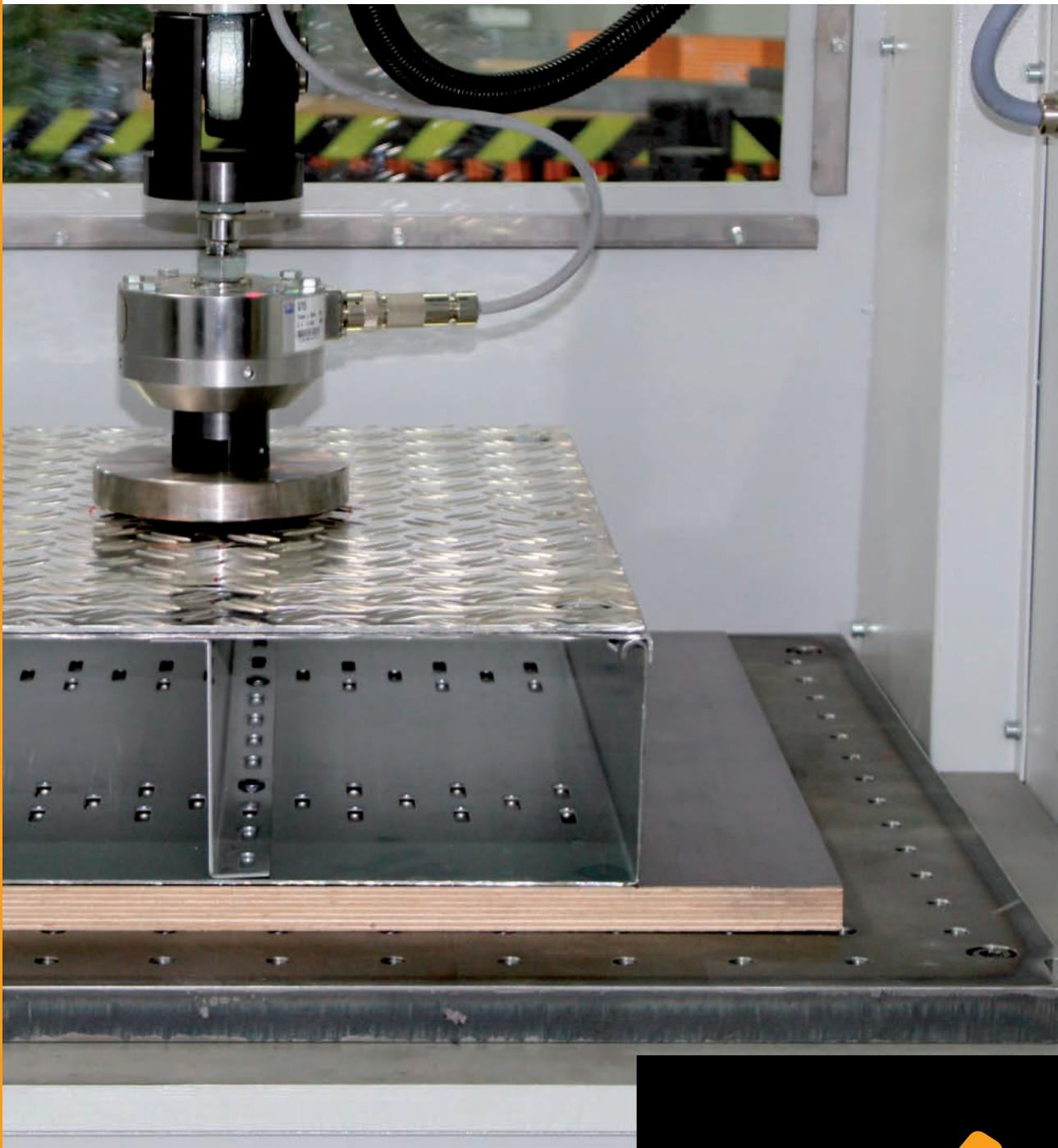

Car manufacturers' in-house standards

The BKRS walkable cable tray system complies with the in-house standards of a wide range of car manufacturers. For each product we provide comprehensive documentation, including all data sheets and load capacity test reports. We also supply all necessary evidence confirming adherence to the automakers' safety specifications.





Direct floor mounting

Installation of the walkable cable tray system directly on the ground.



Stand off application

Installation and fastening of the walkable cable tray system for floor stand-off.



Stand off application

Installation of the walkable cable tray system using DBL stand off bracket.



Mounting on outriggers

Installation of the walkable cable tray system using STA stand off bracket.



Mounting below the walkable cable tray system

Below the outrigger type STA other media such as hydraulic, pneumatic or water can be mounted under the walkable cable tray system. The rails of the support arm allows the use of U-clamps.



Straight connection

The longitudinal connection of the walkable cable tray system by means of straight connector type RLVL.



Mounting Protective panel

The fender type SB is fastened by means of self-drilling screws type BS to the outriggers and is designed to protect people, to prevent accidental tread down the walkable cable tray system to avoid accidents.



Mounting of separating retainer

The barrier strip type TSG is screwed by means of coach bolts in the bottom of the cable tray. Depending on the width of the cable tray system multiple partitions can be used. Here, the divider serves as a lid support.



Use of anti-slip tape

The anti-slip strips is a safety feature in the cover assembly. The strip is stuck and prevents slipping the still unattached lid on the top of the separation pad and thus contributes to accident prevention.



Cover mounting

The specially developed covers are simply placed on the cable trays and fixed by means of an integrated rotary latch.



Using the dust protection element

The dust protection element type SSE is there to prevent the intrusion of foreign particles such as sweat, dust or similar at the butt joints of the covers. The dust protection element is simply pushed between steel sheet and aluminium sheet of the first cover and is therefore easily held in position.



Using the dust protection element

In the second step, the dust protection element is pushed completely between the steel sheet and aluminium sheet.



Using the dust protection element

In the final step, the following cover is simply laid onto the cable tray thereby overlapping the dust protection element.



Creating changes of direction 90 °

For this, the cable trays with the appropriate tools and machines are so cut that this blunt lie to each other. After nesting of cut cable trays they are screwed together by means of longitudinal angled connectors.

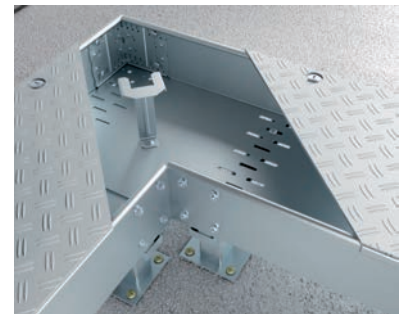

Cover support for BKRS

In moldings that cover additional support type DST is used which reliably prevents a sagging of the lid with larger dimensions. The lid prop is screwed by means of screws in the bottom of the cable tray / the molding.



Equipotential Bonding

Walkable cable tray systems shown with equipotential bonding rail installed.



Mounting with Supplementary bracket

Supplementary bracket installed on STA stand-off bracket to provide additional support.

Cable tray BKRS



Type	Height (H) inch	Width (W) inch	Length (L) feet	Weight lbs/100 ft	Item No.
BKRS 1110 FS	4	4	10	351.89	6061981
BKRS 1120 FS	4	8	10	452.01	6061983
BKRS 1130 FS	4	12	10	552.36	6061985
BKRS 1140 FS	4	16	10	652.93	6061987
BKRS 1150 FS	4	20	10	753.28	6061989
BKRS 1160 FS	4	24	10	853.63	6061991

St Steel
FS Strip-galvanized

The cable tray has connector perforations on both sides.
Straight connectors should be ordered separately and in the appropriate quantity.
Heavy-duty, walk-on cable tray system BKRS with base perforation, in 110 mm side height.

Dimensions

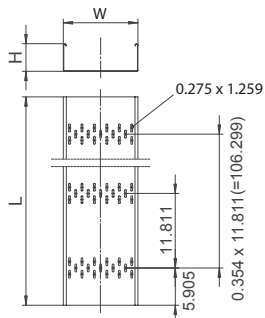

Type	Height (H) inch	Height (H) mm	Width (W) inch	Width (W) mm	Length (L) feet	Length (L) mm	Gauge (t) inch	Gauge (t) mm
BKRS 1110 FS	4	110	4	100	10	3000	0.08	2.00
BKRS 1120 FS	4	110	8	200	10	3000	0.08	2.00
BKRS 1130 FS	4	110	12	300	10	3000	0.08	2.00
BKRS 1140 FS	4	110	16	400	10	3000	0.08	2.00
BKRS 1150 FS	4	110	20	500	10	3000	0.08	2.00
BKRS 1160 FS	4	110	24	600	10	3000	0.08	2.00

Installation

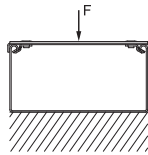

Floor mounting

Type	Support spacing in ft	Cover with plate thickness: 0,236 mm Appr. load in lbs/ft
BKRS 1110	-	2023
BKRS 1120	-	2023
BKRS 1130	-	1573 *
BKRS 1140	-	1573 *
BKRS 1150	-	1573 *
BKRS 1160	-	1573 *

Testing based on DIN EN 50085-2-2

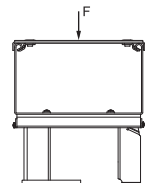

Installation on support bracket

Type	Support spacing in ft	Cover with plate thickness: 0,236 mm Appr. load in lbs/ft
BKRS 1110	3.9	3614
BKRS 1120	3.9	3392
BKRS 1130	3.9	3092
BKRS 1140	3.9	2360
BKRS 1150	3.9	2130
BKRS 1160	3.9	1843

Support element, type STE BKS FS, from 16" width

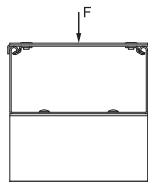

Installation on Z profile

Type	Support spacing in ft	Cover with plate thickness: 0,236 mm Appr. load in lbs/ft
BKRS 1110	3.9	3614
BKRS 1120	3.9	3392
BKRS 1130	3.9	3092
BKRS 1140	3.9	2360
BKRS 1150	3.9	2130
BKRS 1160	3.9	1843

* In order to archive the maximum permitted load, Z-shaped barrier strips must be mounted in cable tray with a width in excess of 8". The maximum distance between the barrier strips is 8".

Straight and angle connector

Type	Height	Pack.	Weight	Item No.
	(H) inch			
RLVL 110 FS	4	10	59.52	6067131

- St Steel
- FS Strip-galvanized

Straight and angle connector for cable trays and fittings with a side height of 110 mm. Including appropriate fastening material.

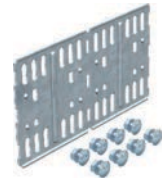
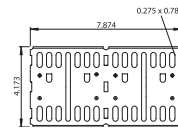

Barrier strip, Z-shaped, side height 4"

Type	Height	Length	Weight	Item No.
	(H) inch	(L) feet		
TSG110Z BKRS FS	4	10	161.72	6062391

- St Steel
- FS Strip-galvanized

Barrier strip for the BKRS walk-on cable tray system. Attachment with truss-head screws M 6 x 12 in the base perforation.

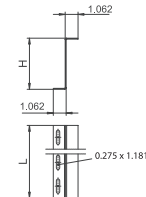

Truss-head bolt

Type	Dimension	Pack.	Weight	Item No.
	mm			
FRSB 6x12 F	M 6 x 12	100	2.18	6406122

- St Steel
- F Hot-dip galvanized

Truss-head bolt with square neck including flange nut.

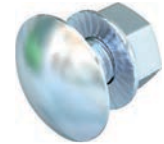
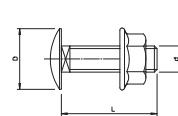

Anti-slip strip

Type	Pack.	Weight	Item No.
ARS BKR	36	6.77	6049259

- GUM Rubber

Self-adhesive, anti-slip strip to stick onto the Z barrier strip in walkable cable trays, for securing laid-on but not yet attached covers.



Reducer/stop-end

Type	Height	Width	Pack.	Weight	Item No.
	(H) inch	(W) inch			
RWEB 110 FS	4	4	1	36.16	7111096
RWEB 120 FS	4	8	1	63.93	7111207
RWEB 130 FS	4	12	1	89.73	7111304
RWEB 140 FS	4	16	1	116.62	7111428
RWEB 150 FS	4	20	1	142.86	7111509
RWEB 160 FS	4	24	1	156.53	7111740

- St Steel
- FS Strip-galvanized

Reducer/stop-end for cable trays with side height 4". From a width of 6", a perforated underbelt is available. Including appropriate fastening material.

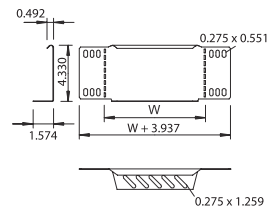
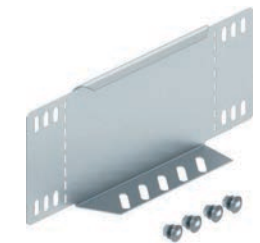

Cover with checker plate and turn buckle, turn buckle spacing 20"

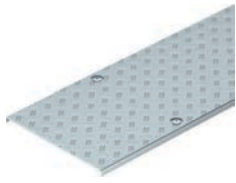

Type	Width (W) inch	Length (L) feet	Gauge (t) inch	Weight lbs/100 ft	Item No.
DF BKR10 FS AL	4	10	0.24	183.00	6049181
DF BKR20 FS AL	8	10	0.24	338.45	6049183
DF BKR30 FS AL	12	10	0.24	493.90	6049185
DF BKR40 FS AL	16	10	0.24	649.57	6049187
DF BKR50 FS AL	20	10	0.24	804.80	6049189
DF BKR60 FS AL	24	10	0.25	960.24	6049191

Alu/St. Aluminium/Steel

Cable tray cover for the walkable BKRS cable tray system. The basic cover is strip galvanized in a material thickness of 0.078" with additional aluminium chequer riveted on in a thickness of 0.157", sturdy and non-slip. Turn buckle fastening with a turn buckle distance of 20".

When using covers outdoors, additional measures against the influence of wind must be taken. Cover clamps or turn buckles on their own are not sufficient securing elements against wind loads.

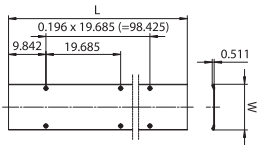

Turn buckle

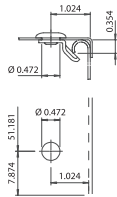

Type	Pack. pcs	Weight lbs/100 pcs.	Item No.
DRL 311 FT	20	2.87	6065007

St Steel

FT Hot-dip galvanized

Turn-buckle for additional installation or installation at a later date.

Single-sided turn-buckle. Use for cover widths of 4" – 24".

Dust protection element



Type	Dim. W inch	Pack. pcs	Weight lbs/100 pcs.	Item No.
SSE BKR 100 FS	4	1	3.59	6049261
SSE BKR 200 FS	8	1	7.17	6049263
SSE BKR 300 FS	12	1	10.74	6049265
SSE BKR 400 FS	16	1	14.31	6049267
SSE BKR 500 FS	20	1	17.90	6049269
SSE BKR 600 FS	24	1	21.47	6049271

St Steel

FS Strip-galvanized

Dust protection element for the insertion between aluminium chequer plate and basic cover in BKRS walkable cable tray systems providing protection against dust, chips, etc.

Cover support, side height 4"

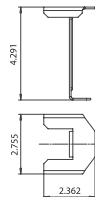

Type	Item No.
DST110 BKRS FS	6049256

St Steel

FS Strip-galvanized

Cover support for the walkable BKRS cable tray system, for additional support of covers and fitting covers at a side height of 4".

Earthing terminal

Type	Dim.	Cross -	Thread	Accessories	Pack. pcs	Weight lbs/100 pcs.	Item No.
	L inch	section mm ²					
EKL 25 M6	0.87	25	M6	—	50	6.83	6404006
EKL 35 M6	1.02	35	M6	—	50	10.58	6404014

CuZn Brass

Earthing terminal for fastening the equipotential bonding wire to the cable support system.

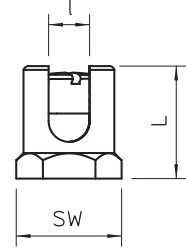

Equipotential bonding rail for small systems

Type	Item No.
1809 BG	5015502

CuZn Brass

- Cover hood made of polystyrene, grey
- Base plate made of strip galvanised steel
- Contact strip and screws made of nickel-plated brass

Connection options:

- 3 x multi-core cables to 6 mm²
- 2 x multi-core cables to 16 mm²

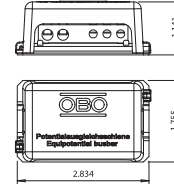

Support profile, side height 4"

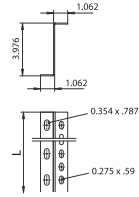

Type	Dim. L inch	Gauge (t) inch	Pack. pcs	Weight lbs/100 pcs.	Item No.
STP Z 1010 FS	4	0.08	1	49.60	6044581
STP Z 1020 FS	8	0.08	1	98.77	6044583
STP Z 1030 FS	12	0.08	1	148.15	6044585
STP Z 1040 FS	16	0.08	1	197.31	6044587
STP Z 1050 FS	20	0.08	1	246.48	6044589
STP Z 1060 FS	24	0.08	1	295.86	6044591
STP Z 10300 FS	118	0.08	3	150.12	6044596

St Steel

FS Strip-galvanized

Support profile for holding up the walkable cable tray system BKRS from the floor. Installation must be performed on both sides of the Z profile during the process of securing the system so that it is held up.

Truss-head bolt

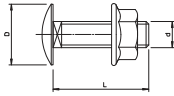
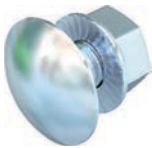

Type	Dimension mm	Pack. pcs	Weight lbs/100 pcs.	Item No.
FRSB 6x12 F	M 6 x 12	100	2.18	6406122

St Steel

F Hot-dip galvanized

Truss-head bolt with square neck including flange nut.

Stand-off bracket



Type	Width (W) inch	Pack. pcs	Weight lbs/100 pcs.	Item No.
STA BKS10 FT	3.81	1	153.22	6044561
STA BKS20 FT	7.75	1	187.17	6044563
STA BKS30 FT	11.69	1	221.12	6044565
STA BKS40 FT	15.62	1	254.85	6044567
STA BKS50 FT	19.56	1	288.81	6044569
STA BKS60 FT	23.5	1	322.76	6044571

St Steel

FT Hot-dip galvanized

Stand-off bracket for holding up the BKRS cable tray system from the floor.

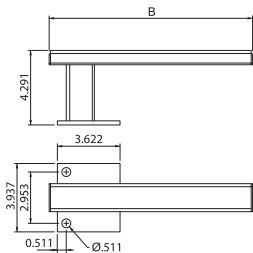

Supplementary bracket

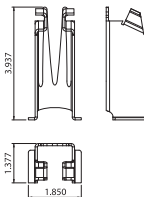

Type	Pack. pcs	Weight lbs/100 pcs.	Item No.
STE BKS FS	10	28.66	6044554

St Steel

FS Strip-galvanized

Additional support for STA stand-off bracket for holding up the BKRS cable tray system from the floor.

Protective panel

Type	Dim.		Weight	Item No.
	h	Length (L)		
	inch	feet	lbs/100 ft	
SB BKS FS	4	10	61.60	6049252

- St** Steel
- FS** Strip-galvanized

Collision guard, to be attached at the side as a collision guard for the walkable BKRS cable tray system. The side height is 108 mm.

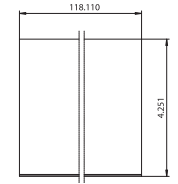

Self-tapping Screws

Type	Dimension	Pack.	Weight		Item No.
			pcs	lbs/100 pcs.	
BS BKS KP	M4,2x16	100	0.40		6049250

- St** Steel
- G** Electrogalvanized

Drilling screw according to DIN 7504.

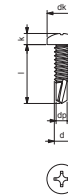

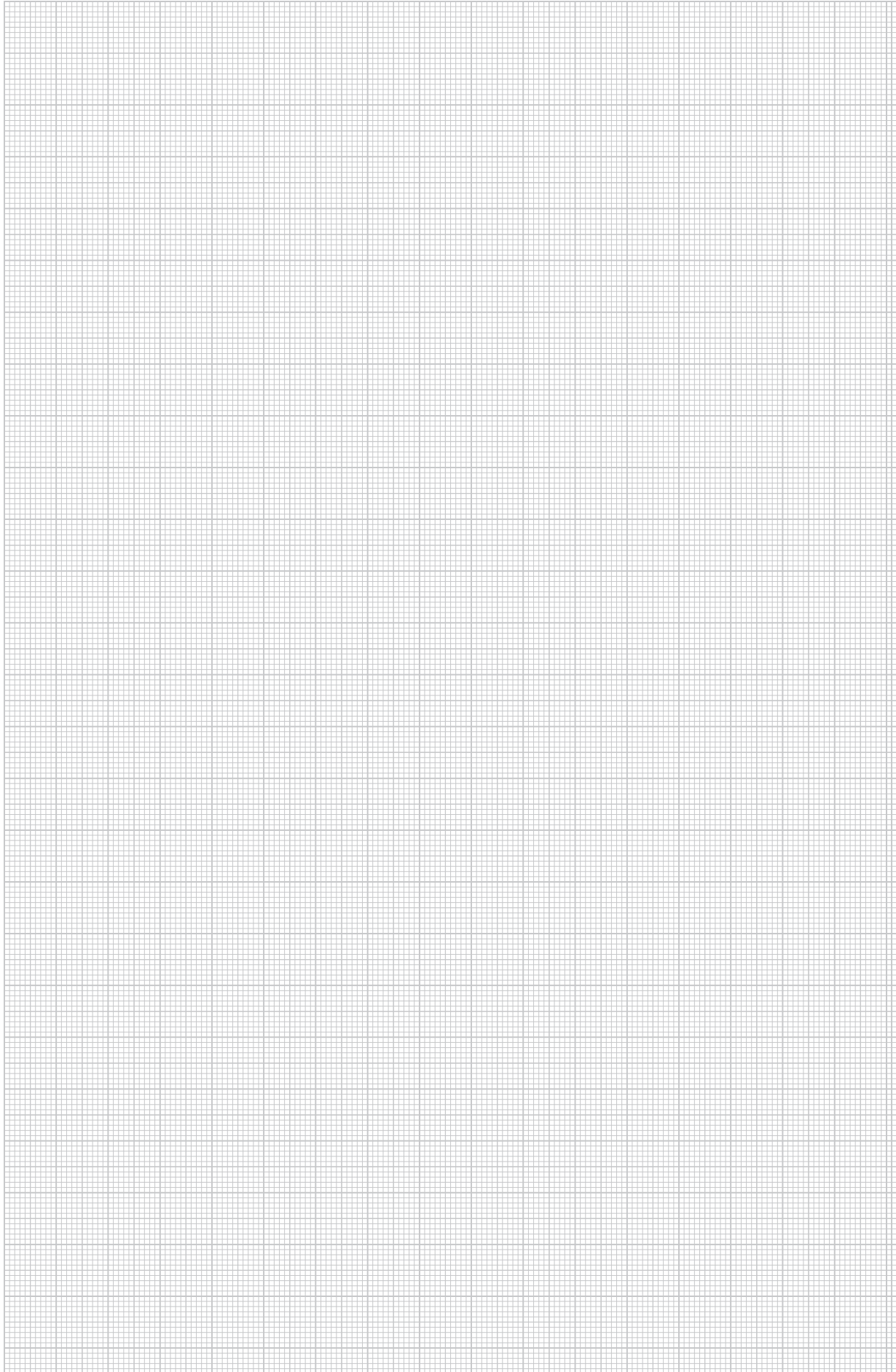

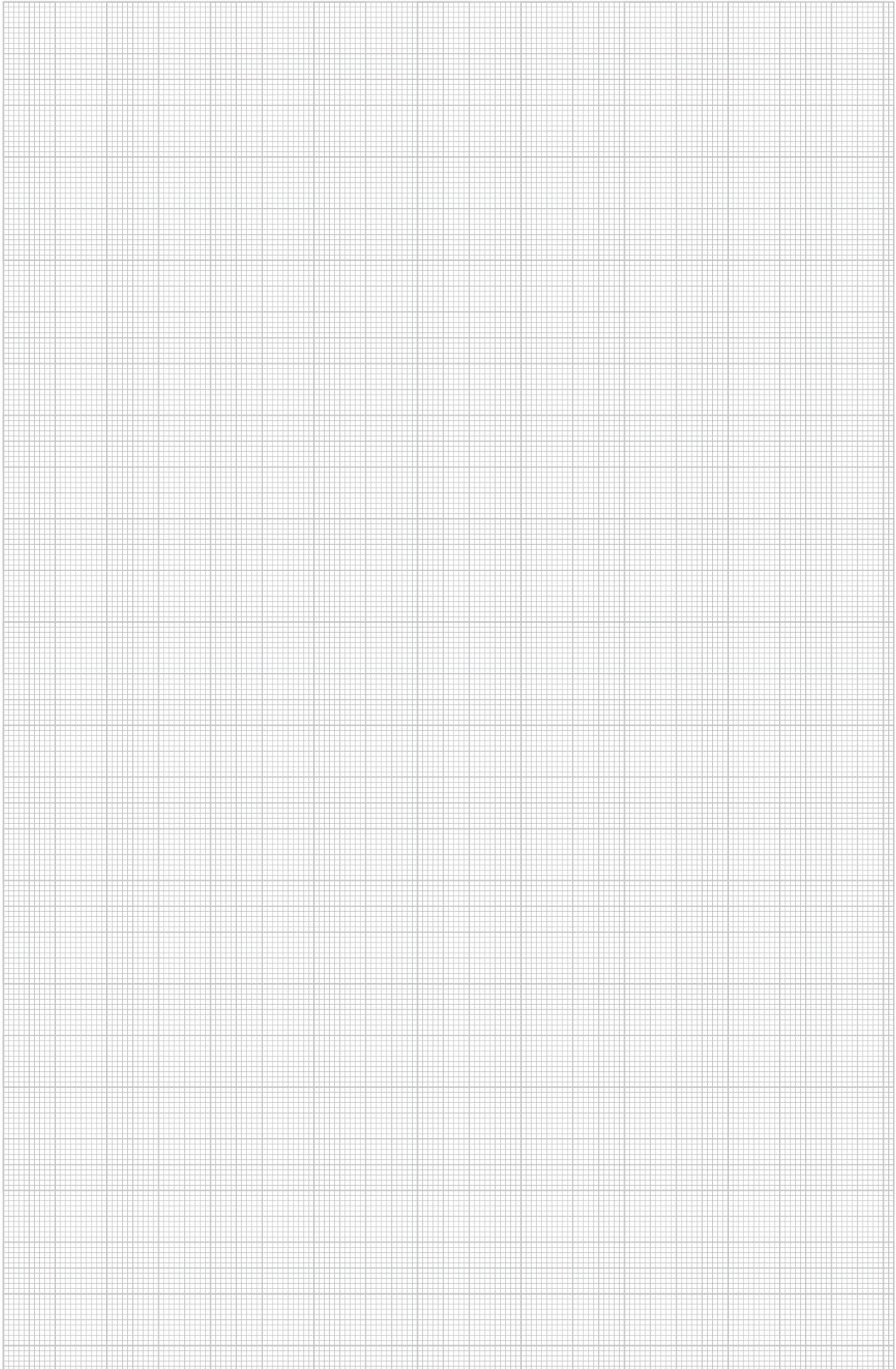

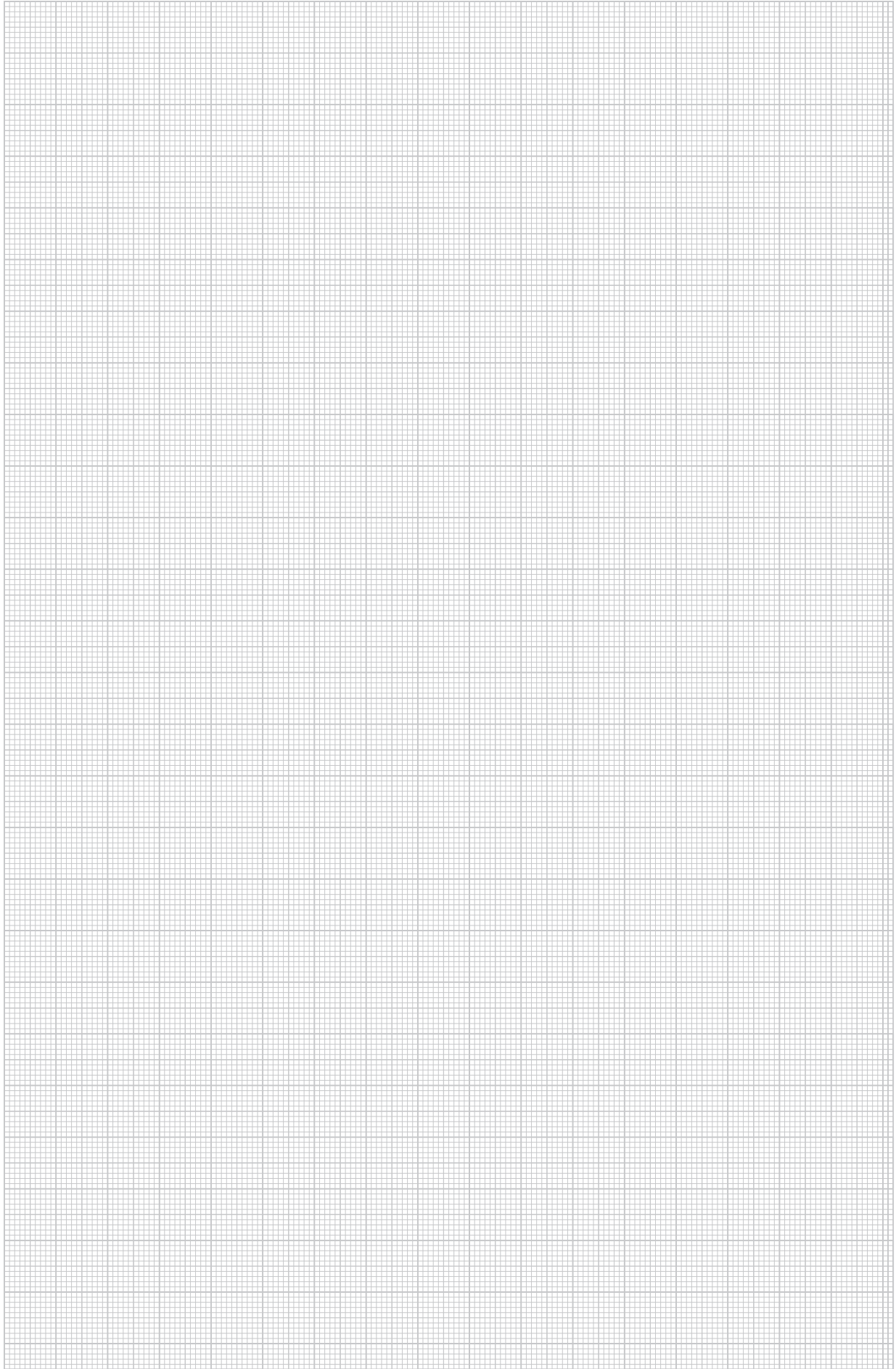

GENERAL TERMS AND CONDITIONS OF SALE

The terms and conditions of sale apply to any sale of products (the "Products ") by Chalfant Manufacturing Company, an Ohio corporation (" Company "), and include liability and remedy limitations and warranty exclusions, including without limitation language excluding the warranty of merchantability and fitness for a particular purpose.

1. General. These general conditions, together with any nonconflicting provisions in company's quotation, are intended by the parties as the final expression, and contain the complete and exclusive statement, of the terms and conditions of this agreement superseding all previous or simultaneous communications either oral or written. Company's quotations are offers which may only be accepted in full. If Purchaser's order or other form states terms additional to or different from those set forth herein, this writing shall be deemed notification of objection to such additional or different terms. This Agreement is conditioned on Purchaser's acceptance and assent to the terms and conditions contained herein. Acceptance of this Agreement shall be deemed to have occurred at the earlier of (i) 7 days from the date specified on Company's acknowledgment form unless written objection is received by Company during such 7 day period, (ii) Company's identification of existing goods as goods to which this Agreement refers, or (iii) onset of Company's manufacture of future goods. This Agreement cannot be waived, varied, modified or amended in any manner (including subsequent conduct between the parties) except in a writing signed by Company. Any portion deemed invalid or unenforceable shall be struck and the remainder of this Agreement shall continue to be effective and binding. This Agreement shall bind and inure to the benefit of the parties and their respective successors and assigns. This Agreement is made under, and for all purposes shall be construed and enforced in accordance with and governed by, the laws of the State Ohio, excluding (i) its conflict of laws provisions and (ii) the United Nations Convention for the International Sale of Goods. All actions arising hereunder shall be instituted in Medina County, Ohio. Purchaser hereby consents to the jurisdiction of the state and federal courts sitting in Medina County.

2. Price and Payment. Unless otherwise stated, all prices for the Products are net Ex Works (INCOTERMS 2000) Company's facility in Brunswick, OHIO ("EXW"), with freight and insurance for Purchaser's account, and shall be those prices in effect at the time Company accepts Purchaser's order except as provided below. As Company's prices are based upon costs and conditions (including exchange rates) existing at time of acceptance, prices are subject to increase as those conditions change, e.g. increase in price of materials and labor and exchange rate fluctuations. Prices exclude all duties, taxes, tariffs, or other charges ("Charges ") which may be imposed upon the sale or use of the Products. All Charges paid by Company shall be for Purchaser's account. Any claim for exemption from Charges must be plainly designated on the face of the order and accompanied by all required exemption certificates. Payments are due net 30 days from the date of invoice, in immediately available funds, without deductions or set-off. Company may require payment to be made C.O.D. or via irrevocable letter of credit in favor of, and acceptable to, Company, established at Purchaser's expense. If payment is not made when due, Company may suspend all future delivery or other performance (including performance of warranty obligations hereunder) with respect to Purchaser without liability or penalty and, in addition to all other sums payable hereunder, Purchaser shall pay to Company (i) the reasonable costs and expenses incurred by Company in connection with all actions taken to enforce collection or to preserve and protect Company's rights hereunder, whether by legal proceedings or otherwise, including without limitation reasonable attorneys' fees, court costs and other expenses and (ii) interest on all amounts unpaid after 30 days charged at the monthly rate of 1-1/2% or the highest rate permitted by law, whichever is lower.

3. Title and Security Interest. Company reserves, and Purchaser hereby grants to and creates in favor of Company, a first priority purchase money security interest in each Product (or the equivalent under Purchaser's local law), including all component parts added by modification or repair, and all proceeds from the sale thereof, until full payment is received. Purchaser agrees to sign upon request, and hereby authorizes Company to sign on its behalf and as its attorney in fact, any documents necessary to perfect Company's security interest. Upon resale, Purchaser agrees to take, and immediately assign to Company, a perfected security interest in each Product.

4. Shipment; Delivery; Inspection. Unless otherwise agreed in writing, shipment and delivery of the Products shall be EXW. All shipment, insurance or similar charges shall be borne by Purchaser. Delivery of the Products to the first carrier shall constitute delivery to Purchaser, whereupon risk of loss is transferred to Purchaser, and all claims for loss or damage in transit or for non-delivery shall be made by Purchaser against the carrier. At Company's option, Products may be shipped in advance of the requested shipment date or in installments. Unless agreed to otherwise in writing on the face of the applicable purchase order by the General Manager of Company (the "Company Representative"), all delivery information (including time for shipment) is approximate. Company's sole responsibility is to use reasonable commercial efforts to meet specified shipment dates. Purchaser expressly absolves Company from any liability for any loss or damage resulting from a failure to deliver or delays in delivery caused by any conditions related to, or caused by, failure to process or inaccurate processing of time-sensitive information and/or mechanisms, a labor dispute (e.g. strike, slowdown or lockout), fire, flood, governmental act or regulation (e.g. denial of export licenses), riot, inability to obtain supplies or shipping space, plant breakdown, power failure, delay or interruption of carriers, accidents, acts of God or other causes beyond Company's control. Notwithstanding the above, Company shall not be liable for any damage or penalties whatsoever, whether indirect, incidental, special or consequential, resulting from company's failure to deliver or delay in delivery for any reason. Within 5 business days of receipt, Purchaser shall inspect the Products. Unless Purchaser notifies Company in writing of any nonconformities within 10 business days of receipt, Purchaser shall be deemed to have accepted the Products without qualification, and cannot, thereafter, reject any Products. Once used or installed, Products are deemed to be fully conforming to this Agreement.

5. Cancellation, Failure to Take Delivery. This Agreement cannot be canceled or postponed by Purchaser except with Company's consent and upon terms that will indemnify Company against loss. If Purchaser cancels all or part of an order for special, non-standard Products ("Specials "), Purchaser shall pay Company the greater of an amount equal to (i) 100% of the price for such cancelled Specials, or (ii) the actual and consequential damages incurred by Company, including without limitation Company's anticipated profit and expenses already incurred by Company. If Purchaser cancels all or part of an order for standard Products ("Standard Products"), Purchaser shall pay Company the greater of an amount equal to (i) 50% of the price for such cancelled Standard Products, or (ii) the actual and consequential damages incurred by Company, including without limitation Company's anticipated profit and expenses already incurred by Company. [In the event the Purchaser requests an extension of the delivery date and Company, in its sole discretion, agrees to extend such date, Company may place such Products either at Company's warehouse in Elyria, OH or in King of Prussia, PA or at an off-site location. In such events, (a) if storage is at an off-site location, all costs incurred by Company in connection with such storage, including, without limitation, costs of preparing such Product for storage, placement into storage, handling, storage/demurrage, inspection, preservation and insurance (or if storage shall be at Company's warehouses, then up to five percent (5%) of the total price of the Products being stored for each month (or portion thereof) of storage), shall be due and payable by Purchaser upon receipt by Purchaser of Company's invoices therefore, and (b) Company's delivery obligations shall be deemed fulfilled and title and all risk of loss or damage to such Products shall thereupon pass to Purchaser, if it has not already passed, and (c) when conditions permit and upon payment of all amounts due hereunder, Company shall arrange, on behalf of Purchaser, and at the cost of Purchaser, for shipment to a destination mutually acceptable to Company and Purchaser.

6. Limited Warranty. Subject to the warranty limitation set forth in Section 7, Company warrants that the Products sold hereunder will be free from defects in material and workmanship for one year after shipment EXW, under normal and proper use and service. Drawings prepared by Company and approved by Purchaser shall be deemed the correct interpretations of the work to be performed even if inconsistent with the plans and specifications. Upon resale, Purchaser agrees to extend to its customers no greater warranties, and limit its liability and remedies to the same extent, as those set forth herein.

7. Warranty Limitation. The warranty and remedies for breach of warranty provided for in these General Conditions extend only to the original installation and do not cover, and Company shall not be liable for, (i) abnormal wear and tear or damage caused by installation, maintenance, or use which is improper or contrary to the instructions published by Company, (ii) storage of Products in a wet or damp area or unprotected from weather and other job conditions, (iii) any cause beyond the control of Company, including without limitation conditions caused by movement, settlement or structural defects of the environment in which the Products are installed, fire, wind, hail, flood, lightning or other acts of God, any conditions related to, or caused by, failure to process or inaccurate processing of time-sensitive information and/or mechanisms, intentional acts, accidents, negligence or exposure to harmful chemicals, pollutants or other foreign matter or energy, (iv) repair or damage caused by anyone except personnel authorized by Company, (v) any damage to the finish of the Products after they leave Company's facility, or (vi) any discoloration or spotty appearance of the Products. Items repaired or replaced and designs corrected under warranty are warranted only for the remainder of the original warranty period. All Product literature is for illustrative purposes only and does not contain a warranty of any kind. Company's advice relating to the technical usage of the Products or the intellectual property rights of others, whether provided orally or in writing or through the provision of test results, is given in accordance with Company's best knowledge at that time, but shall at all times be deemed to be non-binding. Such advice does not relieve Purchaser from the obligation, and Purchaser accepts full responsibility, to confirm for himself the suitability of the Products for the intended purpose(s). The warranty set forth in section 6 is strictly limited to its terms and is in lieu of all other warranties, guarantees, express or implied, arising by operation of law, course of dealing, usage of trade or otherwise, specifically excluding any implied warranties of merchantability or fitness for a particular purpose.

8. Remedy. Purchaser's sole and exclusive remedy, and Company's only obligation for breach of warranty hereunder, shall be, at Company's option in its sole discretion, to (i) repair or replace the defective Product which falls within the one year warranty period, free of charge, provided that Purchaser promptly notifies Company of such failure and, after receipt of prior written authorization from Company, returns such Product to the place requested by Company, freight prepaid, and thereupon Company finds such to be defective or (ii) issue a credit equal to the price of the defective Product which falls within the one year warranty period. Purchaser must pay all related costs of repair or replacement, including removal, installation or reinstallation costs. Company's personnel must be granted access to inspect the Products claimed to be defective at the site of their installation or use.

9. Disclaimer; Limitation of Liability, Time For Claims. Purchaser agrees that Company and its affiliates shall not be liable for any incidental, special, indirect or consequential or other similar damages including but not limited to loss of profit or revenues, damage for loss of use of the Products, damage to property, claims of third parties, including personal injury or death on account of use of the Products or failure of Company to warn against or instruct on, or adequately warn against or instruct on, the dangers of the Products or the safe and proper use of the Products, whether or not Company has been advised of the potential for such damages. Company's total liability hereunder from any cause whatsoever (except liability from personal injury caused by Company's negligence), whether arising under contract, warranty, tort (including negligence), strict liability, products liability or any other theory of liability, will be limited to the lesser of Purchaser's actual damages or the price paid to Company for the Products that are the subject of Purchaser's claim. All claims against Company must be brought within one year after the cause of action arises, and Purchaser expressly waives any longer statute of limitations.

10. Specifications, Intellectual Property. Company assumes no liability for any errors or omissions in any specifications provided or required by Purchaser ("Purchaser Specifications "), including any errors or omissions made by Company in interpreting Purchaser Specifications. Purchaser Specifications not listed and priced by Company are not part of this Agreement. Purchaser agrees, at its own expense, to defend, indemnify and hold harmless Company, its officers, agents, employees and principals, against any and all losses, costs, including investigation costs, damages, claims, liabilities or expenses of any kind, including without limitation reasonable attorneys' fees, arising out of or resulting from, directly or indirectly, any claims of violation of proprietary rights of third parties due to, or injury or death to persons or damage to property caused by, Purchaser Specifications. Company retains all copyrights and other ownership rights with respect to all drawings, models, plans, software, samples, and other documentation (collectively "Company Documentation"). Company Documentation may not be copied or disclosed to others without Company's express written consent and must be promptly returned to Company (i) if an order is not placed or (ii) at Company's request. If an order is not placed in response to Company Documentation, Company is entitled to reasonable compensation.

11. Exports. Purchaser warrants that it is and will remain in compliance with all export and reexport requirements, laws and regulations of the United States of America and any other applicable export and reexport laws and regulations.

12. Change Orders. Any changes to an order requested by the Purchaser shall only be effective upon the written consent thereto, signed by the Company Representative.

Installation

of any of the displaced or listed products should be performed only by properly qualified and trained personnel in compliance with all applicable national, state and local electrical standards, building codes, and other laws and regulations. Proper installation and product selection must take into consideration conditions and materials at the installation site, environmental conditions, manufacturer established parameters for the use of the relevant product. The buyer and installer are responsible for selecting the appropriate product for their application. Failure to comply with the manufacturer instructions or usage parameters, including cutting of modifying any of the products, may result in reduced product life or product failure, potentially resulting in damage to person and property, and will void any manufacturer warranty or approvals, certifications, listings which the product was designed and tested for.

Chalfant Manufacturing Company

Customer Service
50 Pearl Rd, Suite 212
Brunswick, OH 44212-5704
Phone: (330)273-3510
Fax: (330)273-8149

Customer Service
411 Yerkes Rd
King of Prussia, PA 19406
Phone: (610) 768-8852
Fax: (610) 768-8858

www.chalfant-obo.com

Building Connections



OBO Bettermann Group